

ASSEMBLY INSTRUCTIONS

Curve Display - Wood Tower

Part - 7206.002

DATE
1/17/17

Parts List

| ITEM | PART NO | DESCRIPTION | QTY. |
|------|--------------------|---|------|
| 1 | 7206.001-10 | Sign Channel | 1 |
| 2 | 7206.001-11 | Top Cap | 1 |
| 3 | 7206.001-41-2 | Metal Connector -Front | 1 |
| 4 | 7206.001-41-1 | Metal Connector - Back | 3 |
| 5 | 7206.001-65R | Btm Right Panel | 1 |
| 6 | 7206.001-66R | Top Right Panel | 1 |
| 7 | 7206.001-67 | Bottom Shelf Board | 1 |
| 8 | 7206.001-40 | Btm Shelf Bracket | 4 |
| 9 | DMD000182 | Adhesive Glide Strip, 1 1/4" x 1/2" x 1/16" Thick, Off White | 4 |
| 10 | WL-RPH-8-916-B | Washer Lath Screw, Round Head Phillips Drive, #8 x 9/16", Black | 8 |
| 11 | 7206.001-Dowel Pin | Dowel Pin | 6 |
| 12 | CS-BHK-1420-1-B | SCREW, CAP,BUTTON HEAD, HEX KEY DRIVE, 1/4-20x1", Black | 24 |
| 13 | NU-NS-1420-B | NUT, SERRATED FLANGE, 1/4-20, Black | 30 |
| 14 | CS-BHK-1420-12-B | SCREW, CAP,BUTTON HEAD, HEX KEY DRIVE, 1/4 X 1/2, BLACK | 6 |
| 15 | 7206.001-66L | Top Right Panel | 1 |
| 16 | 7206.001-65L | Btm Left Panel | 1 |
| 17 | HK-LA-532-R | Wrench: Hex Key, Long Arm, 5/32", Raw | 1 |
| 18 | 7206.001-42-1 | Top X-Brace | 1 |
| 19 | 7206.001-42-2 | Bottom X-Brace | 2 |

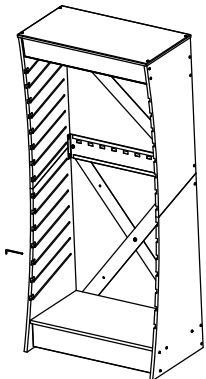
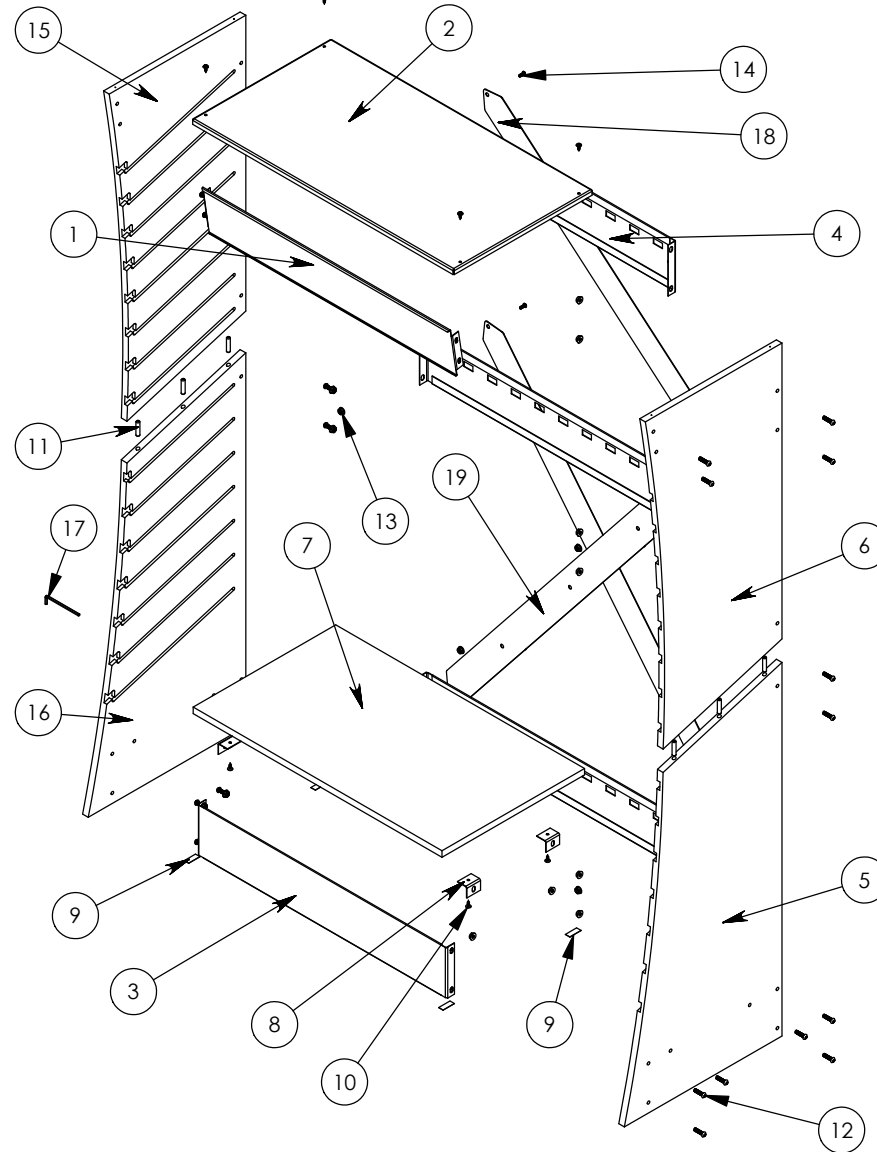

Tools Required for Assembly

Phillips Head Screwdriver
5/32" Hex Key (Supplied)
7/16" Wrench

A&E Gütermann
Consumer Division

Curve Display - Wood Tower

Part Identifier

Sign Channel, 7206.001-10

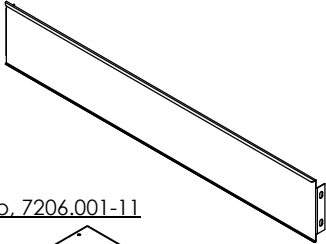

Top Cap, 7206.001-11

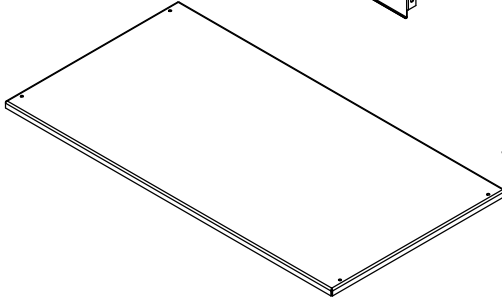

Top Left Panel, 7206.001-66L

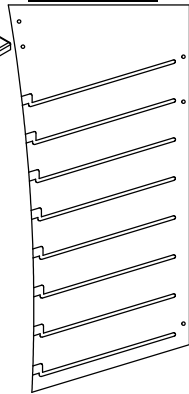

Top Right Panel, 7206.001-66R

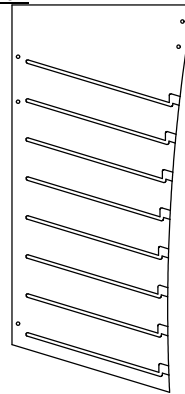

Back Metal Connector, 7206.001-41-1

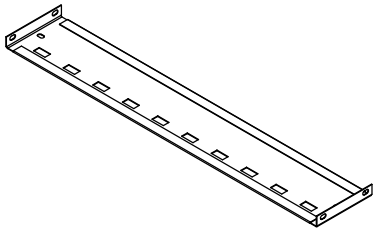

Bottom Left Panel, 7206.001-65L

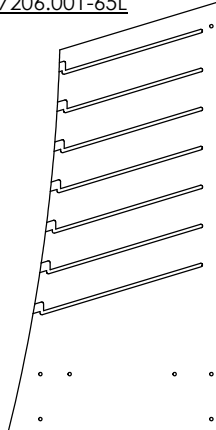

Bottom Right Panel, 7206.001-65R

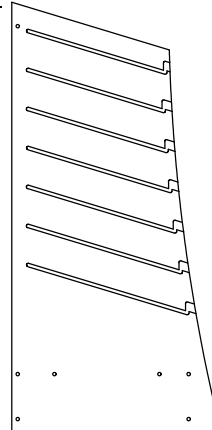

Back Metal Connector, 7206.001-41-2

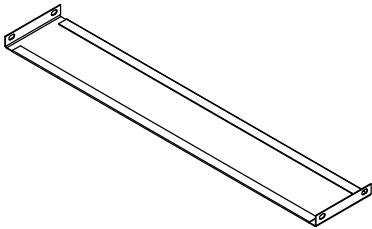

Bottom Shelf Board, 7206.002-67

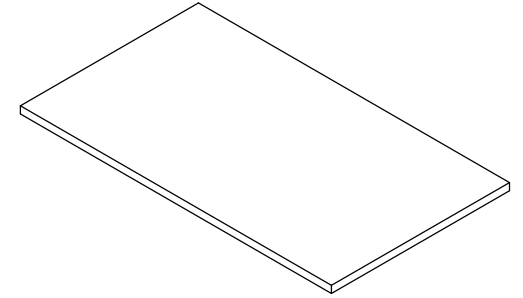

Dowel Pin, 7206.001-Dowel Pin



1/4-20 x 1 Button Head Screw, CS-BHK-1420-1-B



1/4-20 x 1/2 Button Head Screw, CS-BHK-1420-12-B



Washer, Lath Screw, Phillips WL-RPH-8-916-B



1/4-20 Serrated Flange Nut -Black, NU-NS-1420-B



Hex Key, 5/32" Long Arm HK-LA-532-R

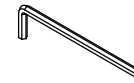

Adhesive Glide Strip, DMD000182

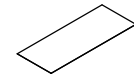

Top Brace, 7206.001-42-1



Bottom X-Brace, 7206.001-42-2

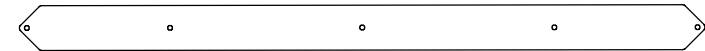

Bottom Shelf Bracket, 7206.001-40

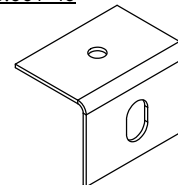

ASSEMBLY INSTRUCTIONS

Curve Display - Wood Tower

Part - 7206.002

DATE
1/17/17

Step 1 - Assemble the Lower Half of the Display.

-Attach Back Metal Connector to the Bottom Right and Left Panels using 1/4-20 x 1" button head screws and 1/4-20 serrated flange nuts as shown. Orient the slots Upward as shown.

-Attach Bottom Shelf Bracket to Bottom Shelf Board using #8 x 9/16" washer lath screws. Note: Bottom Shelf Board has pre-drilled holes on one side to accept the lath screws.

-Attach Bottom Shelf Board and Bottom Shelf Brackets to the Bottom Right and Left Panels using 1/4-20 x 1" button head screws and 1/4-20 serrated flange nuts.

-Attach Front Metal Connector (No holes on face) to the Bottom Right and Left Panels using 1/4-20 x 1" button head screws and 1/4-20 serrated flange nuts as shown.

-Attach Bottom X-Braces to the Back Metal Connectors using 1/4-20 x 1/2" button head screws and 1/4-20 serrated flange nuts. Also Connect X-Brace in center where they intersect with the same fasteners.

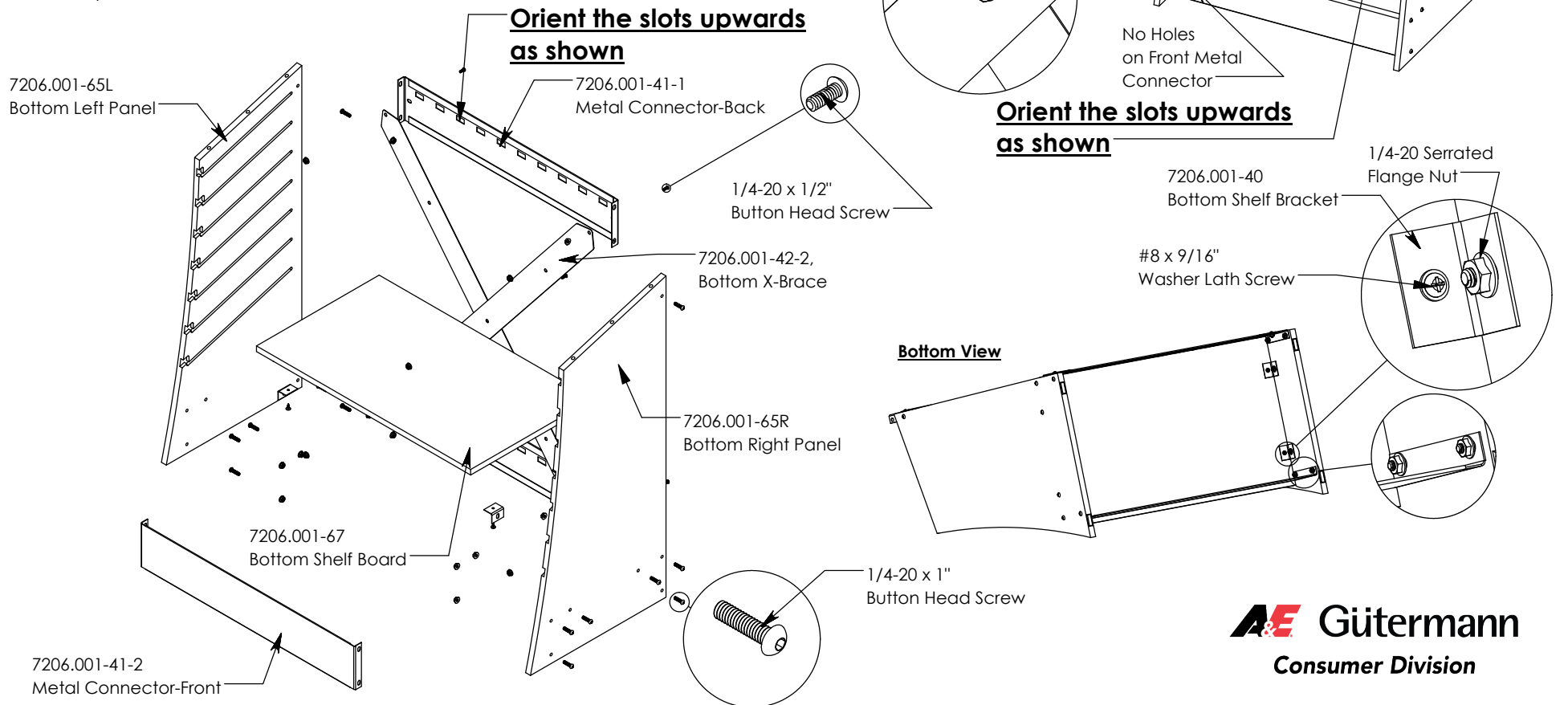

Curve Display - Wood Tower

Step 2 - Assemble the Top Half of the Display.

-Attach Back Metal Connector and Sign Channel to the Top Right and Left Panels using 1/4-20 x 1" button head screws and 1/4-20 serrated flange nuts as shown.

-Attach Top Cap to the tops of the Top Right and Left Panels using #8 x 9/16" Washer Lath Screws. Note: The top edges of the Top Right and Left Panels have pre-drilled holes to accept the lath screws.

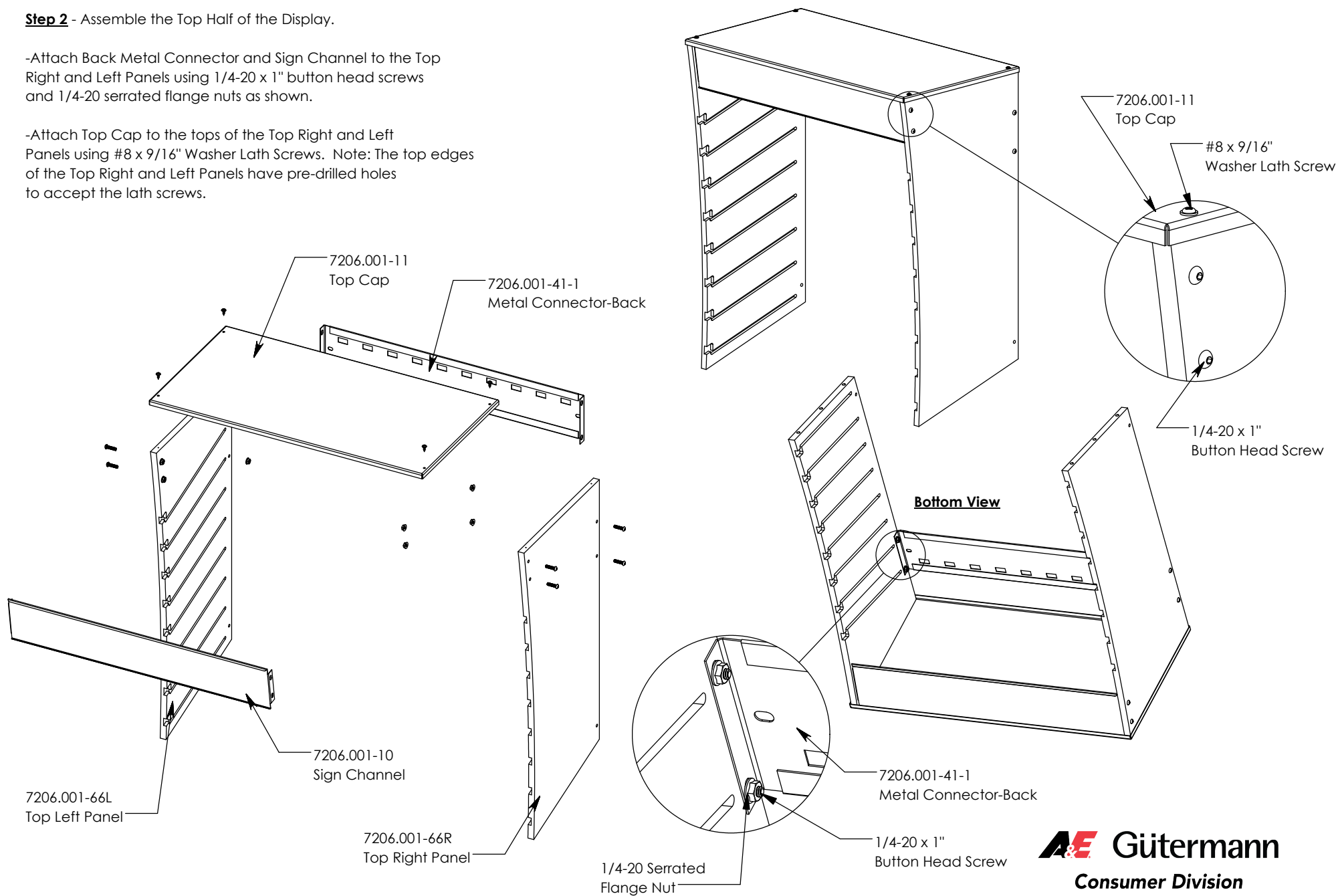

Curve Display - Wood Tower

Step 3 - Connect the Bottom Half to the Top Half.

-Insert Dowel Pins into the holes on the Bottom Right and Left Side Panels.

-Using two people, lift the Top Half up over the Bottom Half and drop it into place so that the dowel pins fall into the holes on the Top Right and Left Side Panels.

-Secure the remaining holes on the Back Metal Connector to the Top Half using 1/4-20 x 1" button head screws and 1/4-20 serrated flange nuts.

-Attach the Top Brace to the Metal Connectors using 1/4-20 x 1/2" button head screws and serrated flange nuts.

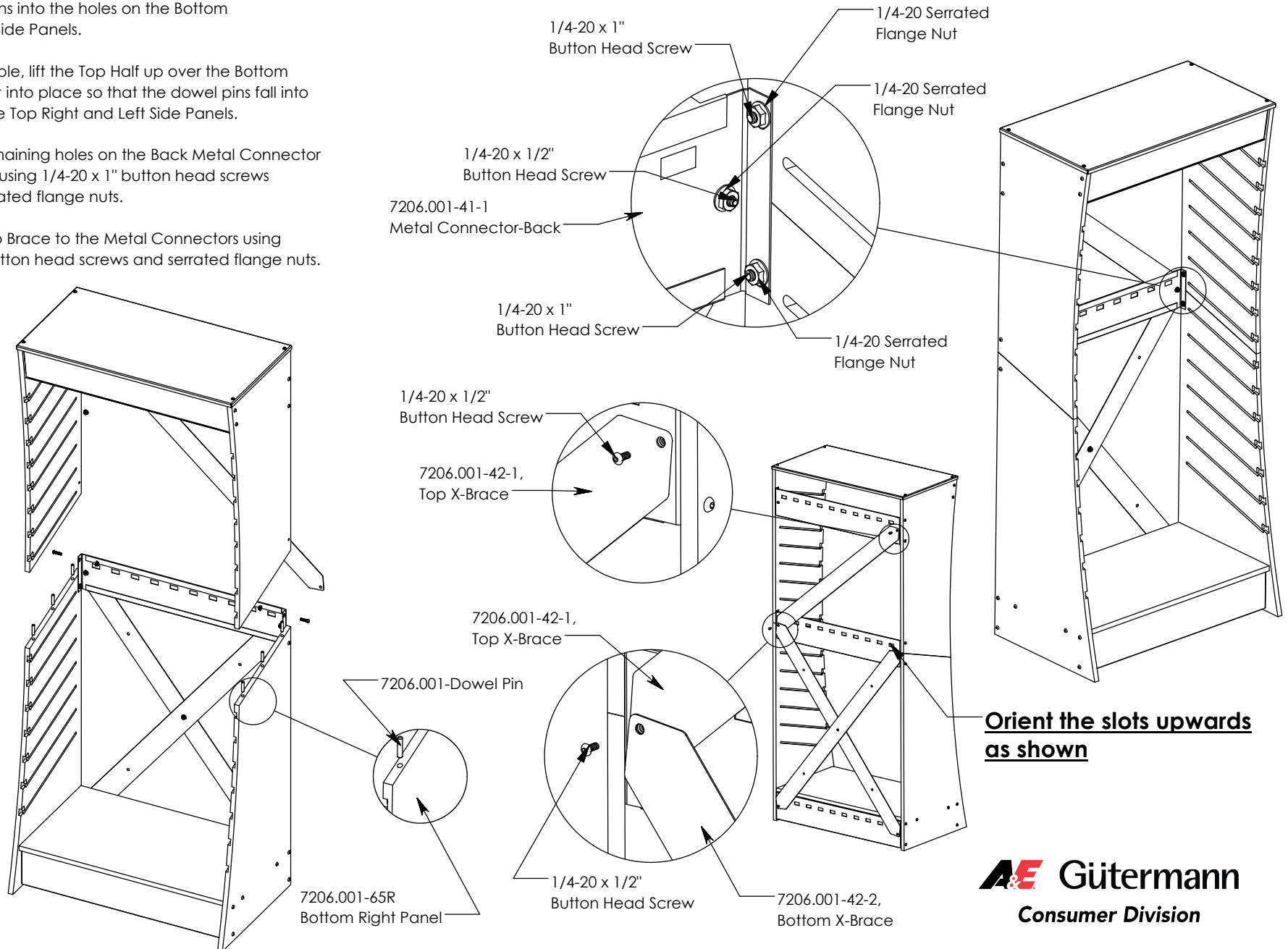

Orient the slots upwards as shown

Step 4 - Install Graphics

Note: Graphics are not supplied with this kit.

-Install Sign into Sign Channel at the top of the display.

-Display is now ready to load with shelves.



Mini King Spool Shelf Kit

Parts List

| ITEM | PART NO | DESCRIPTION | QTY. |
|------|-------------|-----------------|------|
| 1 | 7206.001-50 | Shelf Final Asm | 15 |

Step 1 - Install Shelf Assemblies into the grooved slots on the sides of each wood panel. Load Shelves with Product.

